

PRODUCT SPECIFICATION

Model No.: FYQ-4041K/LX-XX

Descriptions & Features:
<ul style="list-style-type: none"> ■ 0.40 Inch (10.16mm) digit height Four Digit Display ■ Case mold type. ■ RoHS compliant. ■ Low current operation ■ Low power consumption. ■ Easy mounting on P.C. board or socket.

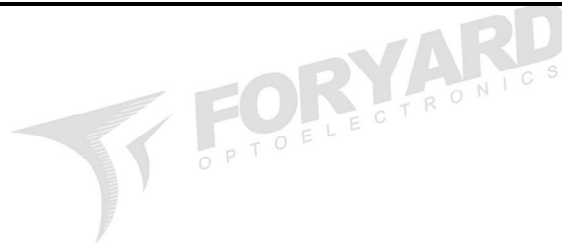

CUSTOMER APPROVED SIGNATURES	APPROVED BY	CHECKED BY	PREPARED BY

NINGBO FORYARD OPTOELECTRONICS CO.,LTD.

Add:NO.666 Jinghua Road, Hi-tech Park, Ningbo, Zhejiang, China

Zip:315103

Tel: 0086-574-87933652 87922206 87927870

Fax: 0086-574-87927917

E-mail:Sales@foryard.com (General)

Model No.: FYQ-4041K/LX-XX

■ -XX: REF Surface / Epoxy color

Color \ Number	0	1	2	3	4
REF Surface Color	<input type="radio"/> White	<input type="radio"/> Black	<input type="radio"/> Gray	<input type="radio"/> Red	<input type="radio"/> Green
Epoxy Color	<input type="radio"/> Water Clear	<input type="radio"/> White	<input type="radio"/> Red	<input type="radio"/> Green	<input type="radio"/> Yellow

■ Mechanical Dimensions

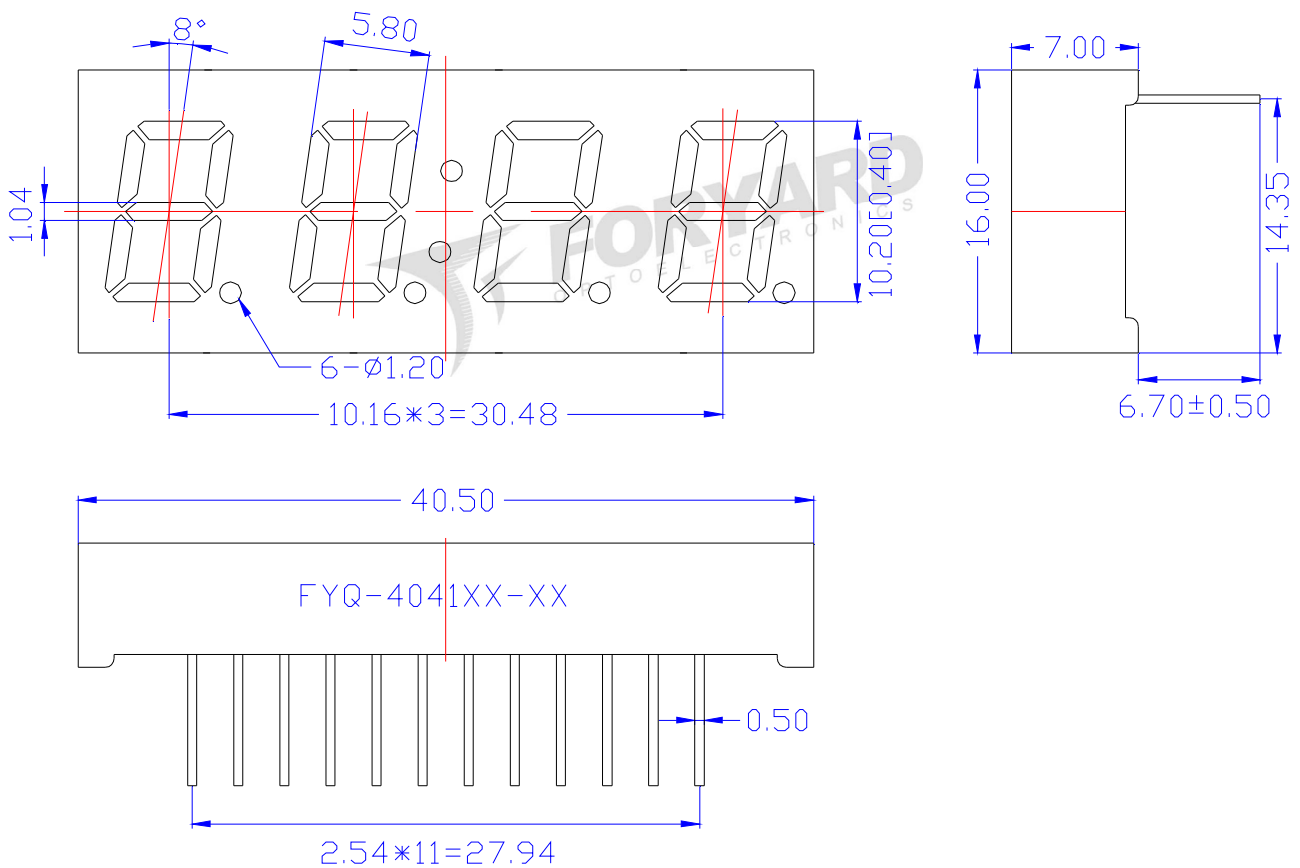

Notes:

1. All pins are $\Phi 0.50 [0.020]$ mm
2. Dimension in millimeter [inch], tolerance is $\pm 0.25 [0.010]$ and angle is $\pm 1^\circ$ unless otherwise noted.
3. Bending \leq Length * 1%.
4. The specifications, characteristics and technical data described in the datasheet are subject to change without prior notice.
5. The drawing is different from the actual one, please refer to the sample.

Model No.: FYQ-4041K/LX-XX

■ All Light On Segments Feature & Pin Position

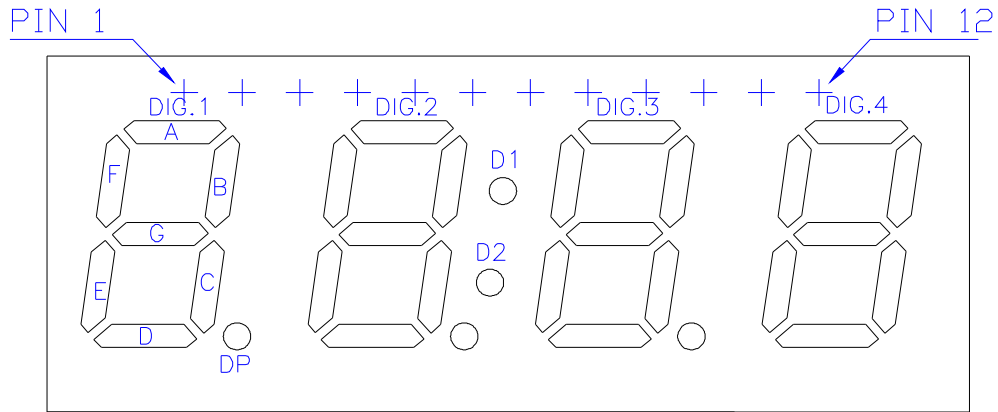

■ Internal Circuit Diagrams

FYQ-4041KX

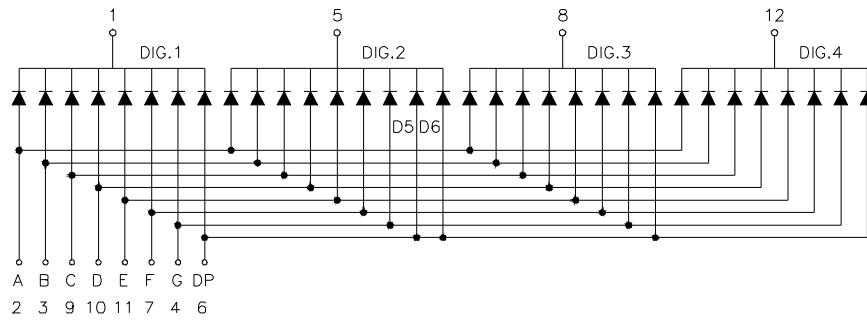

Common Cathode

FYQ-4041LX

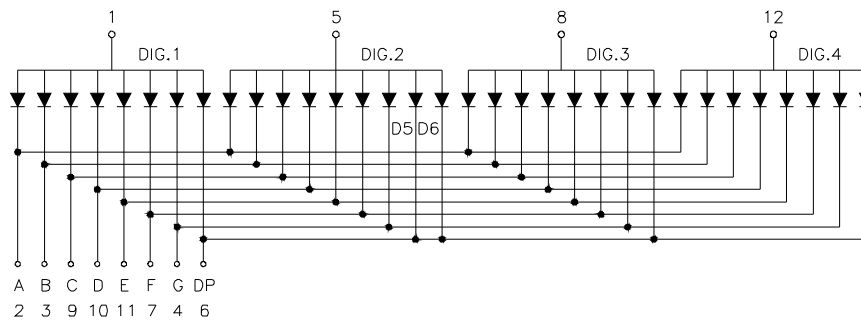

Common Anode

Model No.: FYQ-4041K/LX-XX

■ **Absolute maximum ratings**

(Ta=25°C)

Parameter	Symbol	Test Condition	Value		Unit
			Min	Max	
Reverse Voltage	VR	IR=30	5	—	V
Forward Current	IF	—	—	30	mA
Power Dissipation	Pd	—	—	100	mW
Pulse Current	Ipeak	Duty=0.1mS,1KHz	—	150	mA
Operating Temperature	Topr	—	-40	+85	°C
Storage Temperature	Tstr	—	-40	+85	°C

■ **Electrical-Optical Characteristics**

● **Color Code & Chip Characteristics:(Test Condition:IF=10mA)**

(Ta=25°C)

Emitting Color	Dice Material	Peak Wave Length(λ_p)	Spectral Line halfwidth ($\Delta\lambda_{1/2}$)	Forward Voltage(VF) Unit:V		Luminous Intensity (Iv) Unit:mcd	
				Typ	Max		
Standard brightness							
S	Hi Red	AlGaInP	660nm	20nm	2.00	2.50	10~20
D	Super Red	AlGaAs/DH	650nm	20nm	2.00	2.50	15~30
E	Orange	GaAsP	625nm	35nm	2.00	2.50	10~21
A	Amber	GaAsP	610nm	35nm	2.00	2.50	10~20
Y	Yellow	GaAsP	590nm	35nm	2.00	2.50	10~20
G	Yellow Green	AlGaInP	570nm	10nm	2.00	2.50	10~20
B	Blue	InGaN	460nm	60nm	3.00	3.80	9~20(mw)
			470nm		3.00	3.80	9~20(mw)
W	White	InGaN/GaN	X=0.29,Y=0.30	CCT:9500K	3.00	3.80	60~120~180
Ultra brightness							
UHR	Ultra Hi Red	AlGaInP	640nm	20nm	2.00	2.50	20~50
UR	Ultra Red	AlGaInP	635nm	20nm	2.00	2.50	40~70
UE	Ultra Orange	AlGaInP	625nm	20nm	2.00	2.50	40~85
UA	Ultra Amber	AlGaInP	610nm	20nm	2.00	2.50	30~105
UY	Ultra Yellow	AlGaInP	590nm	20nm	2.00	2.50	30~135
UG	Ultra Yellow Green	AlGaInP	570nm	30nm	2.00	2.50	20~60
PG	Pure Green	InGaN	520nm	36nm	3.00	3.80	350~450
UB	Ultra Blue	InGaN/GaN	460nm	30nm	3.00	3.80	120~180
		InGaN/GaN	470nm	30nm	3.00	3.80	120~180
UW	Ultra White	InGaN/GaN	X=0.29,Y=0.30	CCT:9500K	3.00	3.80	280~600
Segment-to-Segment Luminous Intensity ratio(Iv-M)				1.5:1			

Note:

- 1.Luminous Intensity is based on the Foryard standards.
- 2.Pay attention about static for InGaN

Model No.: FYQ-4041K/LX-XX

■ Packing Diagram

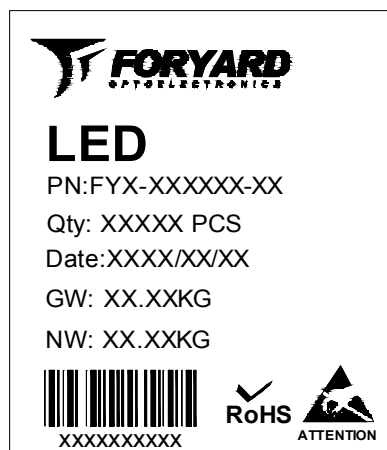
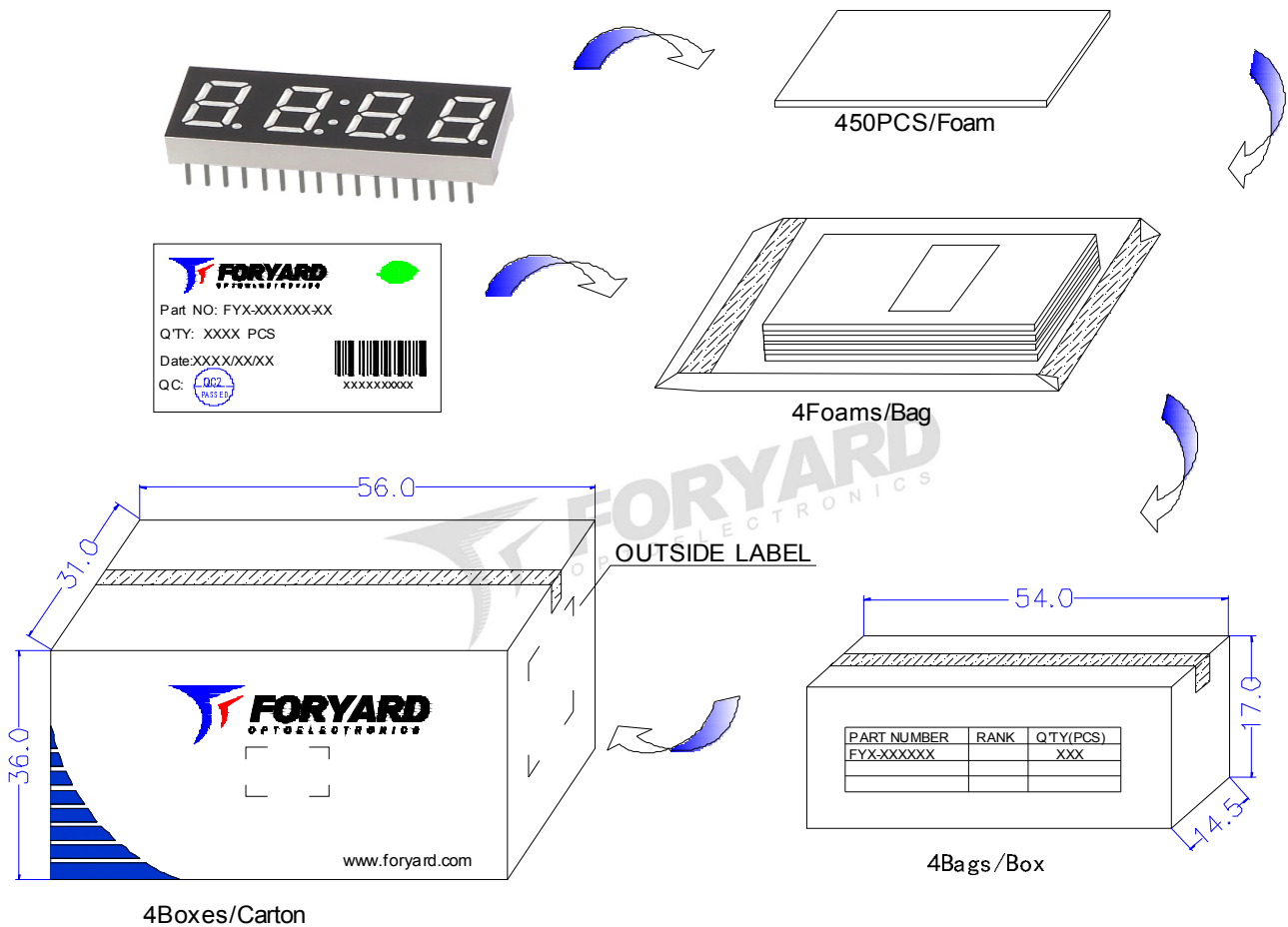

OUTSIDE LABEL